



EN

User Manual

**1/2.8" HD Board Camera, Colour,
1920x1080, WDR, 12VDC**

**MSM-42F0037MPA
MSM-42F0028M0A**

Safety Precaution

- To prevent fire or shock hazard, do not expose the unit to rain or moisture.
- To prevent electric shocks and risk of fire hazards, do NOT use other than specific power source.

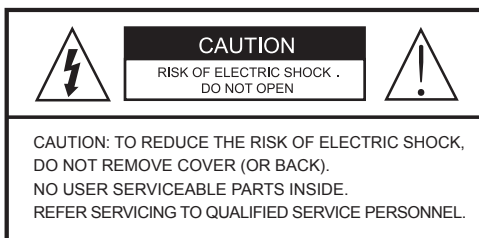

The symbol is intended to alert the user to the presence of uninsulated "dangerous voltage" within the product's enclosure that may be of sufficient magnitude to constitute a risk of electric shock to persons.



The symbol is intended to alert the user to the presence of important operating and maintenance(servicing) instructions in the literature accompanying the unit.

• **Warning :**

This equipment has been tested and found to comply with the limits for a Class A digital device, pursuant to part 15 of the FCC Rules. These limits are designed to provide reasonable protection against harmful interference when the equipment is operated in a commercial environment. This equipment generates, uses, and can radiate radio frequency energy and, if not installed and used in accordance with the instruction manual, may cause harmful interference to radio communications. Operation of this equipment in a residential area is likely to cause harmful interference in which case the user will be required to correct the interference at his own expense.

• **Caution :**

Any changes or modifications in construction of this device which are not expressly approved by the party responsible for compliance could void the user's authority to operate the equipment.

Mains power quality should be that of a typical commercial environment. If the user of the model requires continued operation during power mains interruptions, it is recommended that the model be powered from an uninterruptible power supply (UPS) or a battery.

Safety Precaution

 **NOTICE**

- The image used in this instruction manual are processed to help comprehension and may differ from actual video of the camera.
- Avoid installing areas where has shock or vibration which results in the problems.
- Pay attention to safety when laying the connection cable and observe that the cable is not subjected to heavy loads, kinks or damage and no moisture can get in.
- The warranty becomes void if repairs are undertaken by unauthorized persons.
- Maintenance and repair have to be carried out only by authorized service centers.
- Use only a mild detergent to clean the housing.
- The camera should never be operated beyond the technical specifications.
This can lead to destruction.
- The camera should never be operated in water.

Contents

p.03~04

Safety Precaution

p.05

Contents

p.06

Features

p.07

Composition

p.07

Dimensions

p.08~09

Installation Instructions

p.10~24

Operating Instructions

p.25

Specifications

Features

Key Features

- Full-HD 2Mega pixel, HD-SDI/EX-SDI CAMERA, 1920x1080(30p/25p)
- The best low light performance with 1/2.8" SONY's STARVIS sensor
- Video output EX-SDI 1.0,2.0 / HD-SDI / TVI mode / AHD mode / CVI mode or CVBS Selectable
- TVI mode / AHD mode / CVI mode, Video Transmission Distance over Coax.; 500M
- Lens selectable
 - > MSM-42F0037MPA : f=3.7mm Pin-hole lens
 - > MSM-42F0028M0A : f=2.8mm Fixed lens
- Sensitivity of Color 0.08 Lux, B/W 0.005 Lux
- True WDR(Wide Dynamic Range) 30/25fps
- ROI (Region of Interest) WDR mode:
 - Proper compensation of exposure for each inside and outside of interested area.
 - Better contrast and No motion ghost effect
- Improved Noise figure with the enhanced 3DNR
- Motion Detection, Privacy Mask, Defog, Sens-up(~x32), D-WDR, Sharpness, Mirror/Flip, BLC/HLC, Title Set
- Top performance at low light sensitivity (Sens-up On)
- Selectable Digital output 1080p or 720p
- OSD Menu & Video Sub-out port for easy installation & maintenance (Available by mini jig OSD control board only)
- Remote control through Pelco-C(UTC/HD-TVI), Hikvision
- Circuit protection against faulty connection in power polarity
- Power: DC12V

Composition

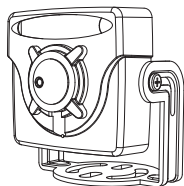

MSM-42F0037MPA

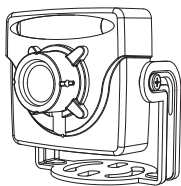

MSM-42F0028M0A

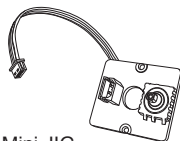

Mini JIG
OSD Control board



Operating
Instruction



Mounting Screw:
BH 3x10mm (2pcs)

Dimensions

(unit : mm)

MSM-42F0037MPA

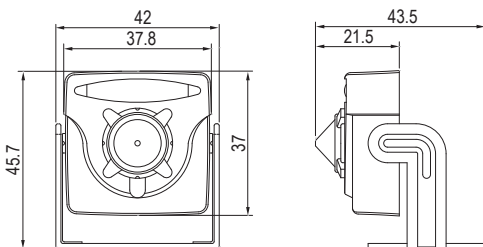

MSM-42F0028M0A

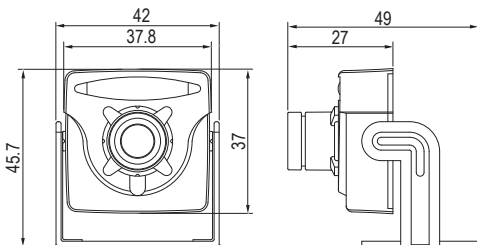

Installation Instructions

1. Place the camera bracket at the installation position and fix it by using mounting screws.
2. Connect the power/video cable then setup the camera menu if necessary.
(Use the mini jig OSD control board)
3. Adjust the camera's viewing angle (Tilt, Rotation)

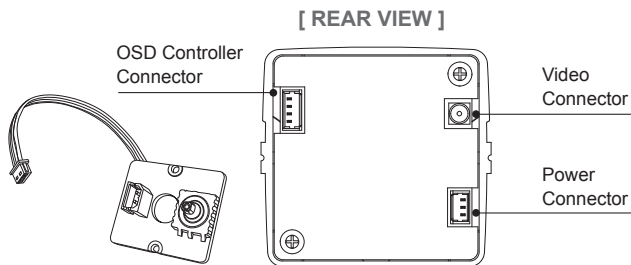
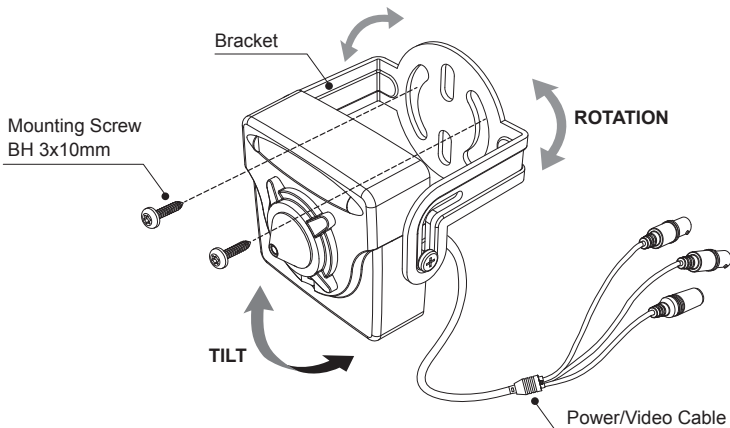

! CAUTION

- Care should be taken the cable is NOT to be damaged, kinked or exposed in the hazardous area.
- Do not expose the camera directly to a strong light source such as the sun or spot light.

Installation Instructions

Power Supply Connections

Camera can be operated with the regulated or unregulated 12VDC but the regulated power supply of 12VDC is recommended.

Camera is protected from the damage by the reverse connection of polarity.

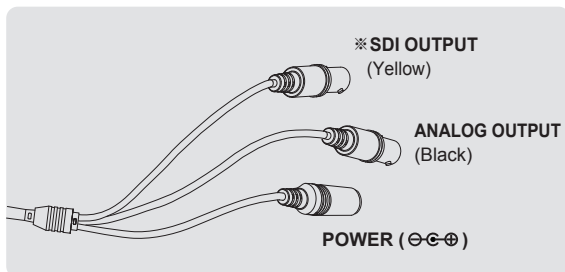

- ※ Please use the cable as provided with camera. If camera cable is cut and re-wired, the transmission distance of video can be reduced. Especially SDI cable should not be cut because it requires detailed wiring job and affects the transmission distance.

Operating Instructions

OSD menu Table

Camera setup menu can be accessed and controlled by OSD controller.

- EXIT : Enters 'EXIT' menu with save current setting or without save.
- RETURN : Returns to the previous menu.

MENU	SUB MENU	CONFIGURATION		
LENS	DC	MODE (INDOOR, OUTDOOR, DEBLUR)		
	MANUAL			
FOCUS Ast.	ON, OFF			
EXPOSURE	BRIGHTNESS	0~20		
	SHUTTER	AUTO		
		MANUAL (SPEED)	1/25, 1/50, 1/100, 1/200, 1/400, 1/800, 1/1600, 1/3200, 1/6400, 1/12800, 1/25600	
		FLICKERLESS		
	SENS-UP	OFF, x2, x4, x8, x16, x32		
AGC	0~10			
BACKLIGHT	OFF			
	HLC	LEVEL, COLOR		
	BLC	H/V-POS, H/V-SIZE		
	WDR	MODE	ROI	WINDOW ZONE/USE, H/V-POS, H/V-SIZE
			NORMAL	
TARGET-BRT	LOW, MIDDLE, HIGH			
WEIGHT	LOW, MIDDLE, HIGH			
DAY & NIGHT	EXTERN	SMART IR, ANTI-SAT., D>N THRES, N>D THRES, DELAY		
	AUTO	SMART IR, ANTI-SAT., AGC THRES, AGC MARGIN, DELAY		
	COLOR			
	B&W	SMART IR, ANTI-SAT.		
COLOR	AWB	AUTO, AUTOext, PRESET, MANUAL (C-TEMP, R/B-GAIN)		
	COLOR GAIN	0~20		
3D-NR	OFF, LOW, MIDDLE, HIGH			
IMAGE	SHARPNESS	MAIN OUTPUT	ANALOG OUT0, ANALOG OUT1, SDI OUTPUT	
		ANALOG OUT0	AHD MODE, CVI MODE, TVI MODE, CVBS	
		ANALOG OUT1	CVBS, TVI MODE, OFF	
		SDI OUTPUT	HD-SDI, EX-SDI 1.0, EX-SDI 2.0, OFF	
	GAMMA	0.45, 0.55, 0.65, 0.75		
MIRROR	OFF, ON			

Operating Instructions

IMAGE	FLIP	OFF, ON	
	D-WDR	OFF, LOW, MIDDLE, HIGH	
	DEFOG	OFF, ON	MODE (AUTO, MANUAL) LEVEL (LOW, MIDDLE, HIGH)
	PRIVACY	OFF, ON	ZONE NUM, ZONE DISP, H/V-POS, H/V-SIZE, Y LEVEL, CB/CR LEVEL, TRANS
MOTION	OFF, ON	DET WINDOW	WINDOW ZONE, WINDOW USE, DET H/V-POS, DET H/V-SIZE
		DET TONE	0~4
		MDRECT FILL	OFF, ON
		SENSITIVITY	0~10
		MOTION OSD	OFF, ON
SYSTEM	OUTPUT	SDI OUTPUT	HD-SDI, EX-SDI 1.0, EX-SDI 2.0, OFF
		ANALOG OUT0	AHD MODE, CVI MODE, TVI MODE, CVBS
	RESOLUTION	1080 25P, 720 25P, 720 50P(Cropped)	
	TV SYSTEM	US(NTSC), EU(PAL)	
	LANGUAGE	ENG, CHN(S), CHN, JPN, KOR, GER	
	CAM TITLE	OFF, RIGHT UP, LEFT DOWN	
	RESET	ON 	
EXIT	SAVE, CANCEL		

- ※ If CVBS video is enabled through ANALOG OUT0 or Sub-out port, WDR and 3D-NR functions are disabled in all video outputs.
It should be considered when installer adjusts the video with installation monitor via CVBS video signal.

Operating Instructions

OSD menu Startup

MENU V0. XX	
1. LENS	MANUAL
2. FOCUS Ast.	OFF
3. EXPOSURE	↓
4. BACKLIGHT	OFF
5. DAY&NIGHT	COLOR
6. COLOR	↓
7. 3D-NR	MIDDLE
8. IMAGE	↓
9. MOTION	OFF
A. SYSTEM	↓
B. EXIT	SAVE ↓

1. LENS (Default: MANUAL)

Lens can be selected either DC or MANUAL lens.
It should be selected according to lens type.

1-1. DC

- DC is for the best image when DC Auto iris Vari-focal lens is installed
- INDOOR: Optimized of indoor environment.
 - OUTDOOR: Optimized of outdoor environment.
 - DEBLUR: It enables to reduce the blur in a certain indoor environment.
Noise or color rolling can be increased.

1-2. MANUAL

MANUAL is for the best image when Fixed lens is installed.

2. FOCUS Ast.

Focus Assist function is useful to set the focus on video.
There are three status bars for short range, middle range and long range.
Shows how exactly focus is set. When green bar with yellow bar appears on columns, try the lens focus to NEAR or FAR. The maximum yellow bar indicates the best focusing position.

Operating Instructions

3. EXPOSURE

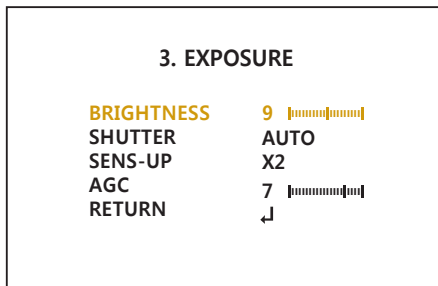

3-1. BRIGHTNESS

Adjusts the brightness of video (0~20).

3-2. SHUTTER

Selects AUTO or set manually.

If SHUTTER set to MANUAL modes, SENS-UP mode is inactivated.

3-2-1. AUTO: Optimizes the video level by controlling the iris and the shutter speed automatically.

3-2-2. MANUAL : 1/25, 1/50, 1/100, 1/200, 1/400, 1/800, 1/1600, 1/3200, 1/6400, 1/12800, 1/25600 Shutter can be set to fix.

3-2-3. FLICKERLESS : Flicker is used to remove the flickering on screen due to differences in light and electric frequencies.

3-3. SENS-UP

The brighter video can be obtained by increasing the exposure time in the night with SENS-UP. It can be set to Off, x2, x4, x8, x16 or x32.

Higher setting can get the brighter video but the slower frame rates with more white pixels.

3-4. AGC

AGC(0~10) amplifies the video gain for brighter video but noise and white pixel accordingly.

Operating Instructions

4. BACKLIGHT

Compensates the video image to cut out the highlight area with mask or control the contrast of video. It can be set the compensation level or areas.

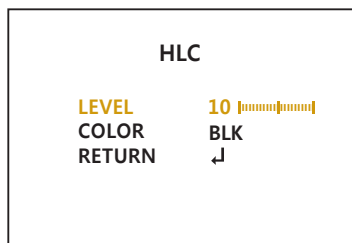

4-1. HLC (High Light Compensation)

Cuts out the highlight area with mask and excludes it from compensation.

4-1-1. LEVEL (0~20): Sets the HLC level. It determines the video level that starts cutting out. Lower setting starts the cut out at lower level.

The cut out area is masked with selected color.

4-1-2. COLOR : Select mask color from 9 colors.

Black, White, Yellow, Cyan, Green, Magenta, Red, Blue and Customize.

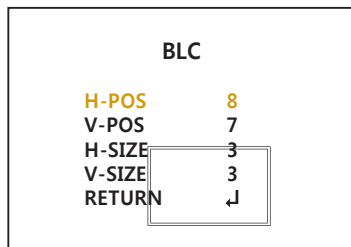

4-2. BLC (Backlight Compensation)

This function is used to brighten an image in the foreground with a highly light area behind it such as sunlight, limiting the affect of silhouette.

BLC has a target window for compensation and its size and position can be set by H-POS, V-POS, H-SIZE and V-SIZE.

4-2-1. H-POS, V-POS :

Sets the position of BLC area to move vertically and horizontally.

4-2-2. H-SIZE, V-SIZE :

Sets the size of BLC area to move vertically and horizontally.

Operating Instructions

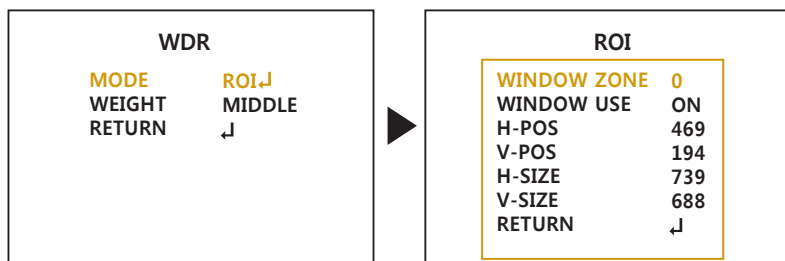

4-3. WDR (Wide Dynamic Range)

WDR is extended the gain range of the video that is mostly useful if camera takes a simultaneous picture of both indoor and outdoor nearby window. It improves contrast of the picture in outdoor scenery as well as indoor. Video outputs image processed from two images by dual shutter (long and short shutter) in a field to provide the best dynamic range. Highlight area is compensated by the short shutter and dark area is compensated by the long shutter. Final video may have less contrast compared to the conventional camera which does not have WDR function.

4-3-1. MODE : Selects WDR mode normal or ROI setting.

- NORMAL: WDR function applies full screen.
- ROI (Region Of Interest) : Sets specific area of WDR by window setting. Select window zone number from 0 to 3 and window use set to on. Then the window zone can be modified position and size.

4-3-2. TARGET-BRT : LOW, MIDDLE, HIGH

Selects the brightness value that you set the target area in MODE.

4-3-3. WEIGHT : LOW, MIDDLE, HIGH

Selects the WDR value that you set the target area in MODE.

- ※ If CVBS video is enabled through ANALOG OUT0 or Sub-out port, WDR and 3D-NR functions are disabled in all video outputs. It should be considered when installer adjusts the video with installation monitor via CVBS video signal.

Operating Instructions

5. DAY & NIGHT

DAY/NIGHT is used to control the setting during day-time and night-time operation. Select the mode according to the light condition and the camera types.

MENU V0. XX	
1. LENS	MANUAL
2. FOCUS ASt.	OFF
3. EXPOSURE	↓
4. BACKLIGHT	OFF
5. DAY&NIGHT	AUTO
6. COLOR	↓
7. 3D-NR	MIDDLE
8. IMAGE	↓
9. MOTION	OFF
A. SYSTEM	↓
B. EXIT	SAVE

5-1. EXTERN (This Camera model is not supported TDN by filter switcher.)

DAY or NIGHT is determined by the built-in light photo sensor.

5-2. AUTO

Used when DAY or NIGHT is determined by light level through the lens and DAY from/to NIGHT is switched automatically by the scene brightness. It can be controlled the AGC threshold level, AGC margin and delay time.

5-2-1. SMART IR (Available only with the built-in LED model)

: SMART IR can be set to reduce the saturation by the strong IR illumination in the night in any menu of EXT, AUTO and B/W(NIGHT). Set to ON, SMART IR is enabled and ANTI-SAT. level is controlled.

5-2-2. ANTI-SAT. (Available only with the SMART IR is ON)

: Sets the anti saturation level 0~20. Setting high level avoids the saturation strongly but the corners will be darker accordingly.

5-2-3. AGC THRES

: AGC(Auto Gain Control) is a threshold level which determines to switch DAY from/to NIGHT in AUTO mode. Higher value makes the camera switch DAY from/to NIGHT at bright illumination.

Operating Instructions

5-2-4. AGC MARGIN

: Sets the gap level switching from/to DAY(color) or NIGHT(B/W).

5-2-5. DELAY

: D→N DELAY is time in second while camera maintains its status before Day to Night switches. DELAY can avoid the unwanted/frivolous switching by a short term lights such as light from the passing car. Sets delay term low, middle or high.

5-3. COLOR (Default: COLOR)

The camera is always in COLOR mode.

Forcibly DAY/NIGHT is disabled and outputs color video.

5-4. B/W

The camera is always in B/W mode.

Forcibly removes IR cut filter and switches to B/W regardless of light level.

5-4-1. SMART IR : OFF (Available only with the built-in LED model)

5-4-2. ANTI-SAT. : NOT USED (Available only with the SMART IR is ON)

Operating Instructions

6. COLOR

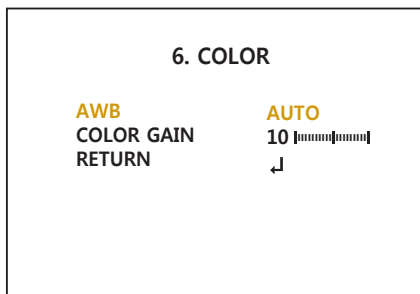

6-1. AWB (Auto White Balance)

Automatically tracks the changes of color temperature and continuously adjusts the white balance. AUTO, AUTOext, PRESET and MANUAL modes are available.

- 6-1-1. AUTO : Optimized for Indoor installation and more easily compensates AWB for low color temperature such as incandescent lights.
- 6-1-2. AUTOext : Optimized for outdoor sunlight applications and more easily compensates AWB for high color temperature such as sunlight.
- 6-1-3. PRESET : AWB is performed only whenever ● is pressed.
- 6-1-4. MANUAL : White balance is fixed to the settings by Color-Temperature Red-GAIN and Blue-GAIN. It can be used only when the color temperature does not vary.

6-2. COLOR GAIN

Sets the color gain control level 0~20.

Operating Instructions

7. 3D-NR (Digital Noise Reduction)

DNR function improves picture quality by filtering out signal noise which is generated under the low light conditions. Sets off, low, middle or high level. 3DNR(3-dimensional noise reduction) which reduces the noise by the multi frames. It is effective at low light. Setting high is strength of noise reduction but the result may occur in loss of sharpness and the tail effect of a comet.

MENU V0. XX	
1. LENS	MANUAL
2. FOCUS ASt.	OFF
3. EXPOSURE	↓
4. BACKLIGHT	OFF
5. DAY&NIGHT	AUTO
6. COLOR	↓
7. 3D-NR	MIDDLE
8. IMAGE	↓
9. MOTION	OFF
A. SYSTEM	↓
B. EXIT	SAVE ↓

※ If CVBS video is enabled through ANALOG OUT0 or Sub-out port, WDR and 3D-NR functions are disabled in all video outputs.
It should be considered when installer adjusts the video with installation monitor via CVBS video signal.

8. IMAGE

8. IMAGE	
SHARPNESS	↓
GAMMA	0.55
MIRROR	OFF
FLIP	OFF
D-WDR	OFF
DEFOG	OFF
PRIVACY	OFF
RETURN	↓

SHARPNESS	
MAIN OUTPUT	SDI OUTPUT
SDI OUTPUT	HD-SDI
SDI&CVBS	5 []
HD-C-MODE	5 []
HD-T-MODE	6 []
HD-A-MODE	7 []
RETURN	↓

Operating Instructions

8-1. SHARPNESS

Sets the Sharpness level 0~10. Increases or decreases the sharpness of the picture. Too much sharpness can make image harsh and show more noise as well as line flicker at the edge of object in the picture.

8-2. GAMMA

Adjust gamma level of video.

8-3. MIRROR

The Video is reversed left and right if it turns ON.

8-4. FLIP

The Video is reversed upside down if it turns ON. When the video is flipped by Vertical, then the joystick directions are reversed accordingly. It is very useful when a camera is installed in upside

8-5. D-WDR

Improves the visibility for the high bright area and the dark area by compensating the video gain. Care should be taken to select low, middle or high level, because video may lose its quality in some environments by the over compensation. Video noise can be increased in the dark area accordingly.

8-6. DEFOG

Enhance the foggy video according to status of scene. Video quality can be less in normal environments. Sets AUTO or MANUAL mode.

8-6-1. MODE :

- AUTO : Enhance the foggy video automatically according to status of scene.
- MANUAL : Sets to enhance the foggy video manually regardless of status of scene.

8-6-2. LEVEL : Sets Low, Mid or High.

Video quality can be less in normal environments.

8-7. PRIVACY

Sets ON/OFF for enabling/disabling PRIVACY mask. 16 privacy areas are available and each area is programmable in size, color, position and transparency.



8-7-1. ZONE NUM : Selects mask zone number from 0 to 15 to be adjusted.

8-7-2. ZONE DISP: Displays OFF/ON for the mask area which you selected zone.

8-7-3. H-POS, V-POS :

Adjusts the mask area H, V position which you selected zone.

Operating Instructions

PRIVACY	
ZONE NUM	0
ZONE DISP	ON
H-POS	12
V-POS	2
H-SIZE	3
V-SIZE	3
Y-LEVEL	10 
CB LEVEL	10 
CR LEVEL	10 
TRANS	0
RETURN	↵

8-7-4. H-SIZE, V-SIZE :

Adjusts the mask size using H, V direction which you selected zone.

8-7-5. Y LEVEL : Adjusts the mask color by Y LEVEL. (0: black ~ 20: white)

8-7-6. CB LEVEL : Adjusts the mask color by CB LEVEL. (0: yellow ~20: blue)

8-7-7. CR LEVEL : Adjusts the mask color by CR LEVEL. (0: Green ~20: magenta)

8-7-8. TRANS.: Selects transparency rate for the mask area from 0 to 3

- 0 : Privacy mask is not transparent.
- 1 : Privacy mask is 25% transparent.
- 2 : Privacy mask is 50% transparent.
- 3 : Privacy mask is 100% transparent.

9. MOTION

4 motion detection areas are available and each area is programmable in size and location. The motion can be detected the changes in the motion areas and displays the results in blocks and/or a text message.

9-1. DET WINDOW. Sets the MOTION DETECTION areas on screen.

9-1-1. WINDOW ZONE : Set the detection zone number from 0 to 3.

9-1-2. WINDOW USE : Sets ON/OFF motion detection area which you selected. If set to ON, It can be adjusted position and size.

9-1-3. DET H-POS, V-POS :

Adjusts the detection area H, V position which you selected zone.

9-1-4. DET H-SIZE, V-SIZE :

Adjusts the area size using H, V direction which you selected zone.

Operating Instructions

A. SYSTEM

Sets the system related functions.

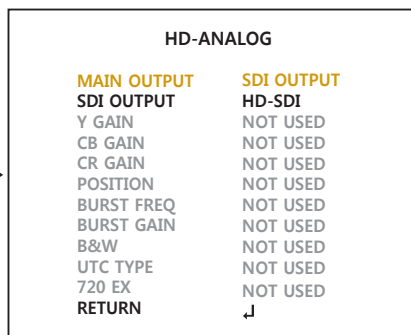
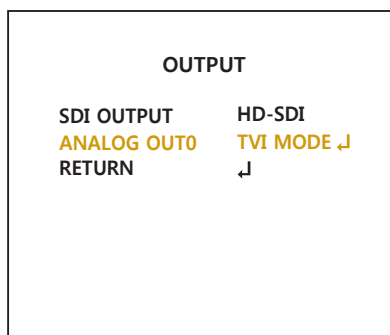
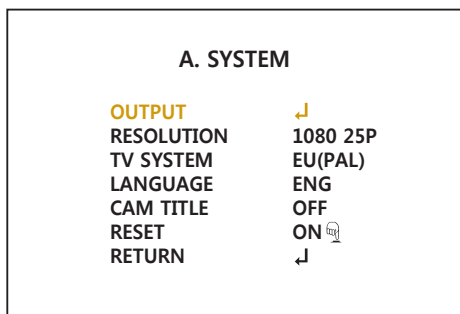

A-1. OUTPUT

Selects the main video output.

A-1-1. SDI OUTPUT :

Selects the SDI output OFF, HD-SDI, EX-SDI 1.0, EX-SDI 2.0

A-1-2. ANALOG OUT0 :

Selects HD-ANALOG modes AHD MODE, TVI MODE, CVI MODE or CVBS.

Please set ANALOG OUT0 to AHD MODE, TVI MODE or CVI MODE if CVBS video is necessary through sub-out port.

If ANALOG OUT0 is set to CVBS, there is no CVBS video through sub-out port and sub-out port outputs CVBS video only.

Operating Instructions

- ※ If CVBS video is enabled through ANALOG OUT0 or Sub-out port, WDR and 3D-NR functions are disabled in all video outputs. It should be considered when installer adjusts the video with installation monitor via CVBS video signal.

A-2. RESOLUTION

Select the video resolutions, 1080P/720P are available. 1080P outputs 1920x1080 video at the frame rate of 30P/25P. 720P outputs 1280x720 video at the frame rate of 60P/50P.

A-3. TV SYSTEM

Selects HDTV standards for analog video output switches to 60HZ, US(NTSC) or 50HZ, EU(PAL) accordingly.

A-4. LANGUAGE

6 languages are available for OSD menu. English, Korean, Japanese, Chinese(S), Chinese, German.

A-5. CAM TITLE

Camera title(name) can be set and edited with alphanumeric characters. Select the camera title position 'LEFT DOWN' or 'RIGHT UP' on the video. Then ◀, ▶ moves the cursor and ▲, ▼ choose a character to select it. The selected characters are added and displayed on the input line.

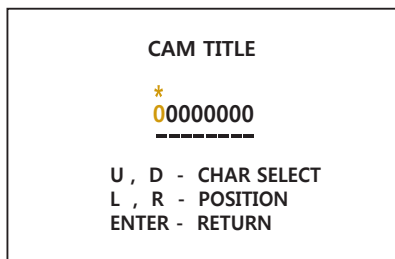

A-6. RESET : Loading Factory Default.

B. EXIT : Exits SETUP MENU and returns to the normal display.

B-1. SAVE : Save all the setting and exit the setup menu.

B-2. CANCEL : Exit the setup menu without save.

Specifications

ITEM	MSM-42F0037MPA	MSM-42F0028M0A
Imaging Sensor	1/2.8" Sony 2Mega pixel CMOS STARVIS Sensor	
Effective Pixels	1920(H) x 1080(V) x 25p	
Scan Frequency	25Hz(V), 18.75Khz(H) / Progressive	
Video Format	HDJ 16:9, 1080p@25fps ----- CVBSJ 16:9 (PAL)	
Video Output	EX-SDI 1.0, 2.0 /HD-SDI / TVI mode/ AHD mode/ CVI mode/ CVBS	
Synchronization	Internal	
Video Resolution	30/25fps@2M (1920x1080)	
Min.Illumination	Color: 0.08 Lux, B/W: 0.005 Lux	
S/N Ratio	More than 50dB (AGC Off)	
Lens	f=3.7mm Pin-hole lens	f=2.8mm Fixed lens
Exposure	Brightness / Shutter / Sens-up / AGC	
Day & Night	Soft Day & Night	
Auto White Balance	AUTO / AUTOext / PRESET / MANUAL	
WDR	True WDR by dual scan images in two frames at 30fps/25fps	
ROI-WDR	Yes	
DNR	3D-NR	
Digital Zoom	Not Supported	
Remote Control	Pelco-C(UTC/HD-TVI), Hikvision	
Functions	Motion Detection (Motion OSD/ TEXT Alarm), Defog, Sens-up(~x32), Privacy Mask, D-WDR, BLC/HLC, Mirror/Flip, Sharpness, Title Set	
OSD Language	English, Korean, Japanese, Chinese(S) / Chinese, German	
Video Output	VBS 1Vp-p ± 10%, 75Ω	
Operating Temp.	-10°C ~ +50°C (Humidity: 20%RH ~ 80%RH)	
Operating Power	DC12V=150mA, Circuit protection against faulty connection in power polarity.	
Housing	Aluminum Cast, 2-Axis bracket	
Dimension(mm)	37.8(W) x 21.5(D) x 37(H) w/o bracket, 42(W) x 43.5(D) x 45.7(H) with bracket	37.8(W) x 27(D) x 37(H) w/o bracket, 42(W) x 49(D) x 45.7(H) with bracket

(*) Design and specifications are subject to change for product improvements without prior notice.



eneo® is a registered trademark of
VIDEOR E. Hartig GmbH
Exclusive distribution through special-
ised trade channels only.

VIDEOR E. Hartig GmbH
Carl-Zeiss-Straße 8
63322 Rödermark/Germany
Tel. +49 (0) 6074 / 888-0
Fax +49 (0) 6074 / 888-100
www.videor.com
www.eneo-security.com

Technical changes reserved

© Copyright by VIDEOR E. Hartig
GmbH Version 10/2017